

GH161/161A

GH161/161A Series

Applications: Camera, Vidicon, Household Appliances,
Toys and other Precision Instruments ect.



Operating environment: $-10 \sim +60^{\circ}\text{C}$; 15~90%RH

Characteristics

MODEL	NOMINAL VOLTAGE	RATED LOAD	NO LOAD		RATED LOAD	
			CURRENT	RATED SPEED	CURRENT	RATED SPEED
			V	g.cm	mA	rpm
GH161	2.5	300	≤ 300	85	≤ 600	65
GH161A	2.5	300	≤ 300	110	≤ 600	80

Outline Drawing

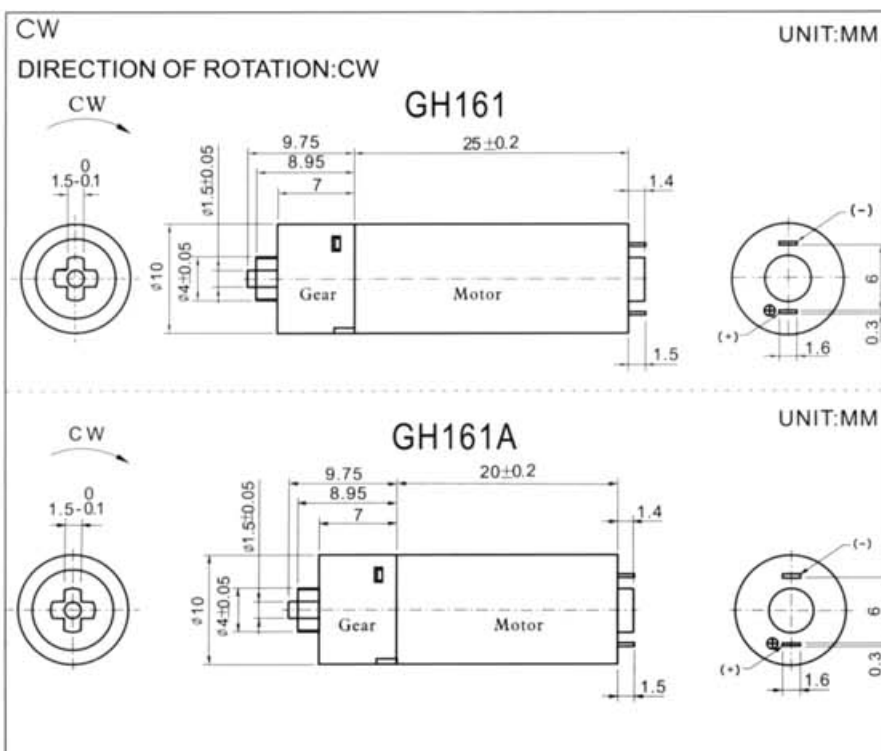

Characteristics Drawing

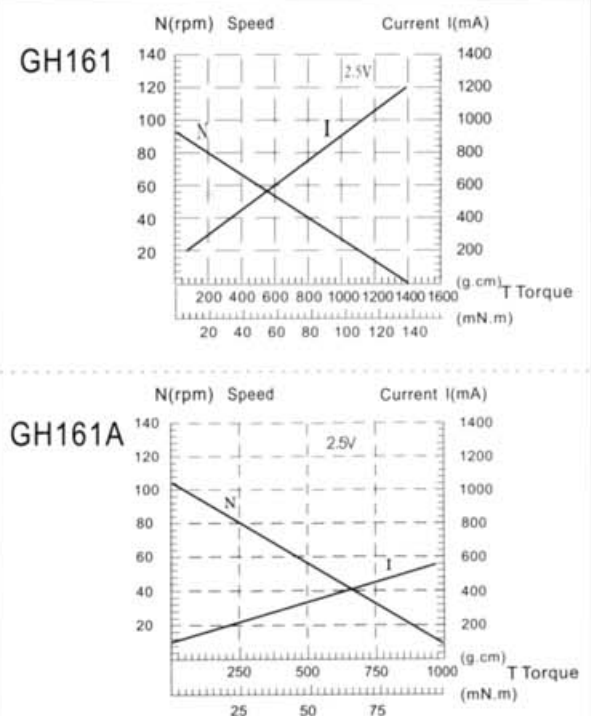

GH163 Series

Applications: Camare, Vidicon, Household Appliances
and Toy etc.

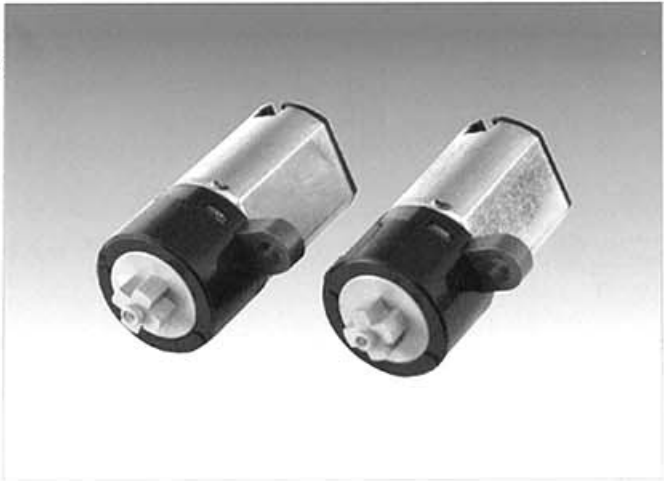

Operating environment: -10~+60°C ; 15~90%RH

Characteristics

MODEL	NOMINAL VOLTAGE	RATED LOAD	NO LOAD		RATED LOAD	
			CURRENT	RATED SPEED	CURRENT	RATED SPEED
			V	g.cm	mA	rpm
GH163	2.5	150	≤200	120	≤400	75

Outline Drawing

Characteristics Drawing

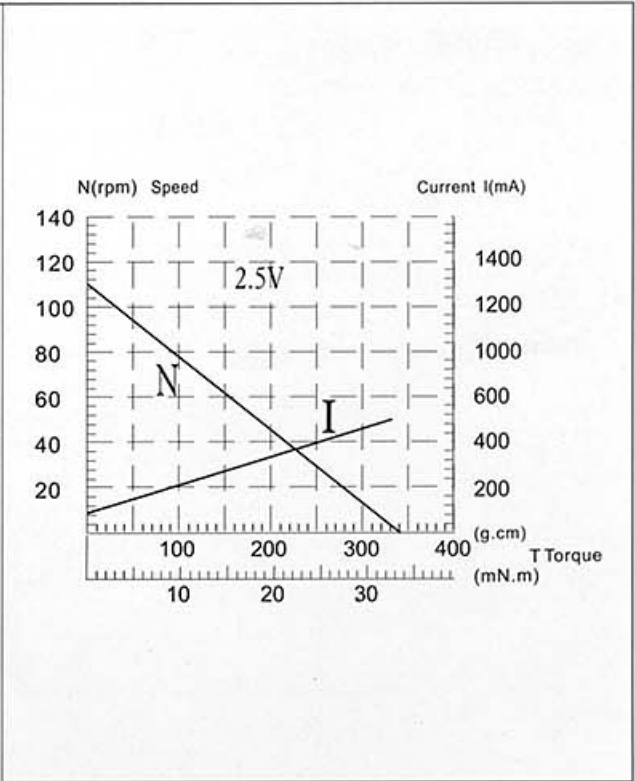
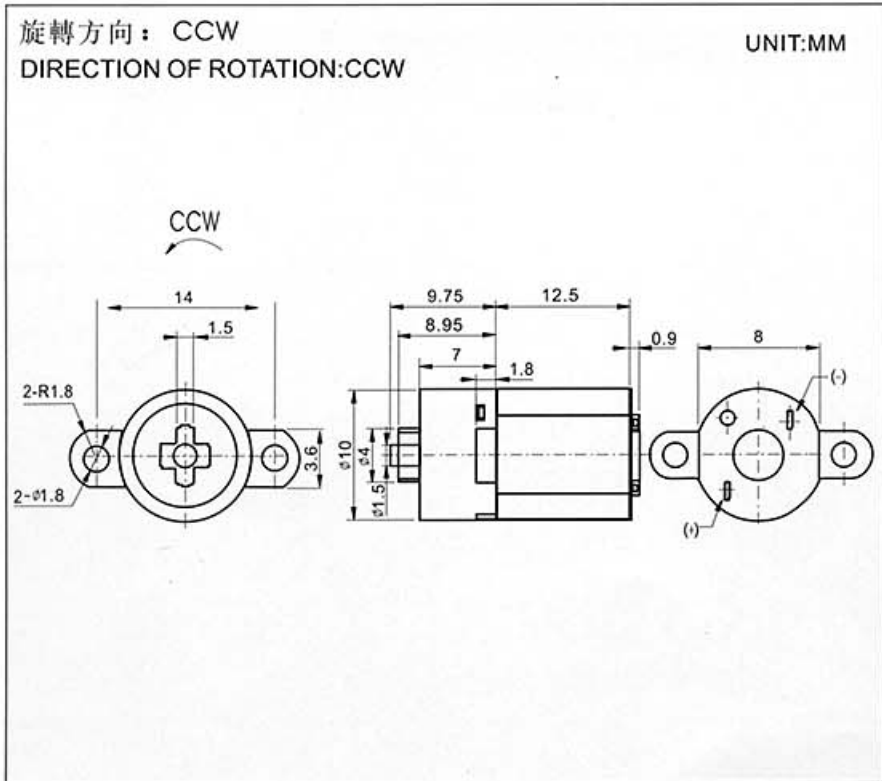

GH130/132 Series

Applications: Camera, Vidicon, Household

Appliances and Toys etc.

Operating environment: $-10\sim+60^{\circ}\text{C}$; $15\sim90\%\text{RH}$

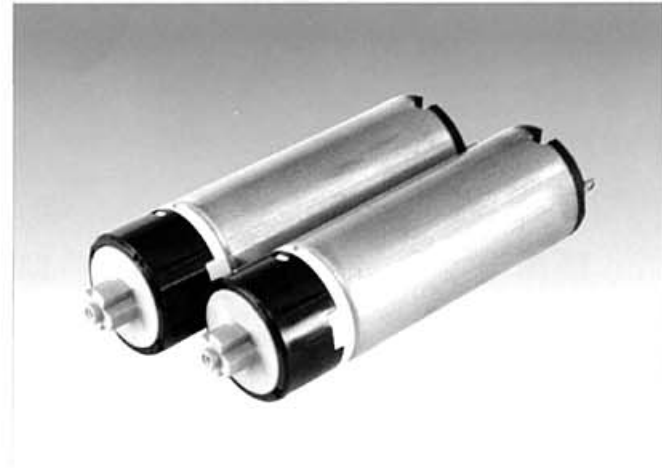

Characteristics

MODEL	NOMINAL VOLTAGE	RATED LOAD	NO LOAD		RATED LOAD	
			電 流 CURRENT	額 定 轉 數 RATED SPEED	電 流 CURRENT	額 定 轉 數 RATED SPEED
			V	g.cm	mA	rpm
GH130	2.5	300	≤ 300	> 80	≤ 600	> 55
GH132	5.0	300	≤ 120	80	≤ 410	65

Outline Drawing

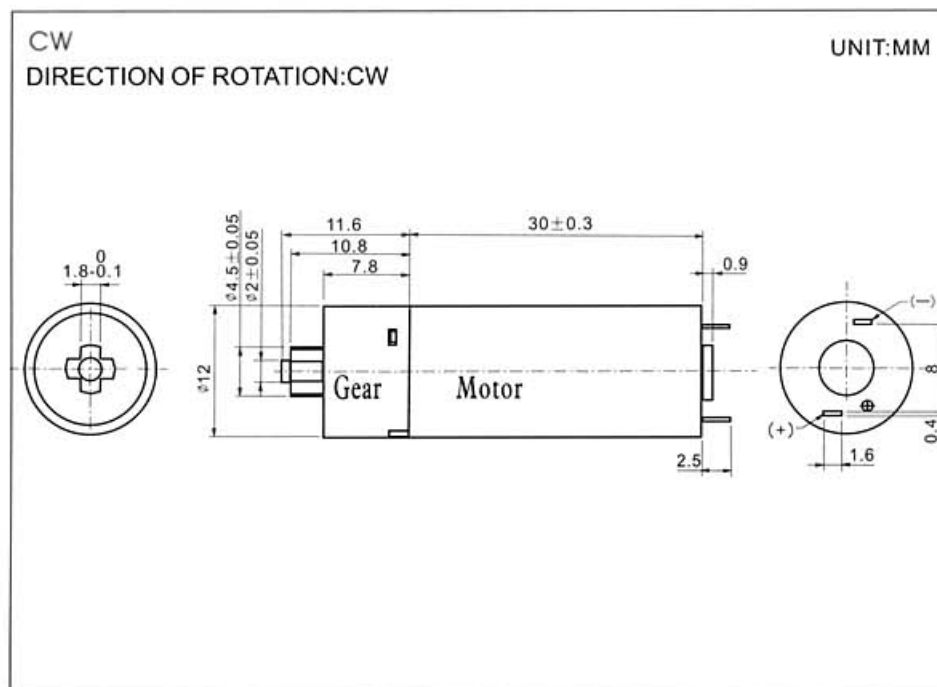

Characteristics Drawing

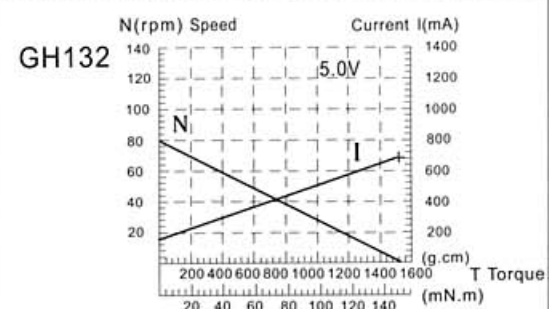
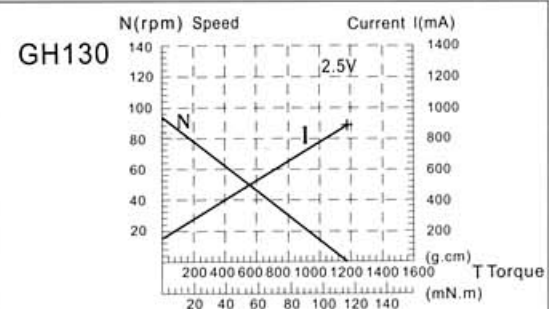

Applications: Camera, Vidicon, Household Appliances
and Toy etc.



Operating environment: -10~+60°C ; 15~90%RH

Characteristics

MODEL	NOMINAL VOLTAGE V	RATED LOAD g.cm	NO LOAD		RATED LOAD	
			CURRENT	RATED SPEED	CURRENT	RATED SPEED
			mA	rpm	mA	rpm
GH133	2.5	150	≤200	>70	≤300	>50
GH133B	5.0	150	≤100	>70	≤150	>50

Outline Drawing

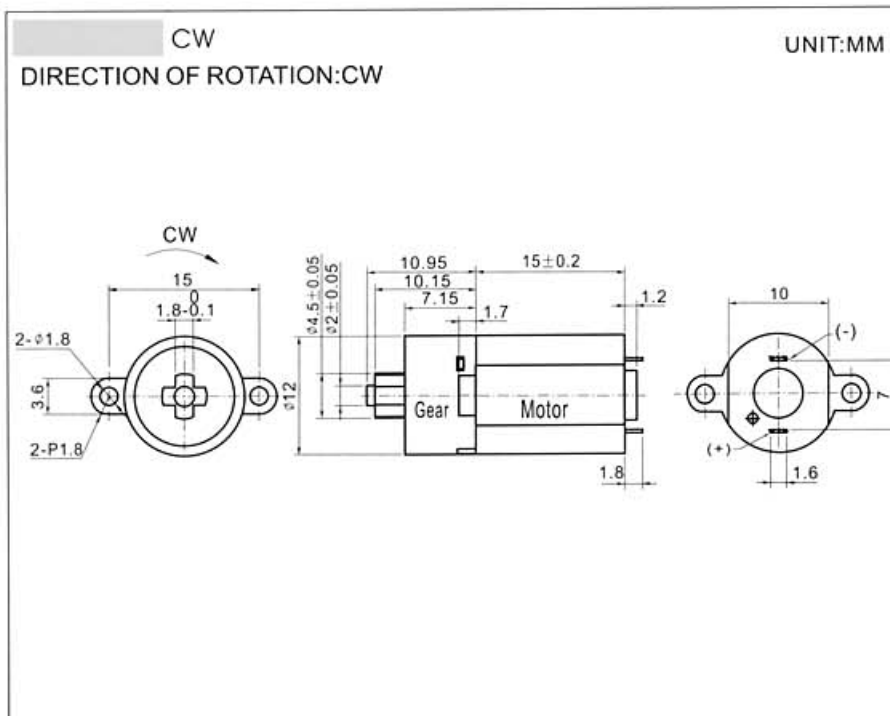

Characteristics Drawing

