

## GH161/161A

## GH161/161A Series

Applications: Camera, Vidicon, Household Appliances,

Toys and other Precision Instruments ect.

Operating environment:  $-10 \sim +60^{\circ}\text{C}$  ; 15~90%RH

## Characteristics

MODEL	NOMINAL VOLTAGE	RATED LOAD	NO LOAD		RATED LOAD	
			CURRENT	RATED SPEED	CURRENT	RATED SPEED
			V	g.cm	mA	rpm
GH161	2.5	300	$\leq 300$	85	$\leq 600$	65
GH161A	2.5	300	$\leq 300$	110	$\leq 600$	80



## Outline Drawing

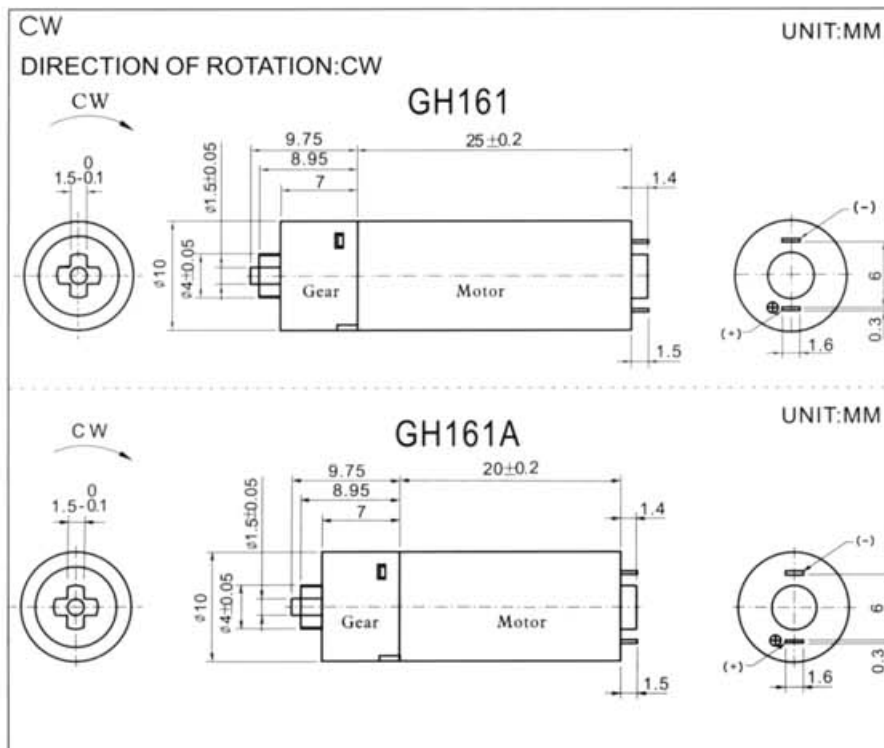

## Characteristics Drawing

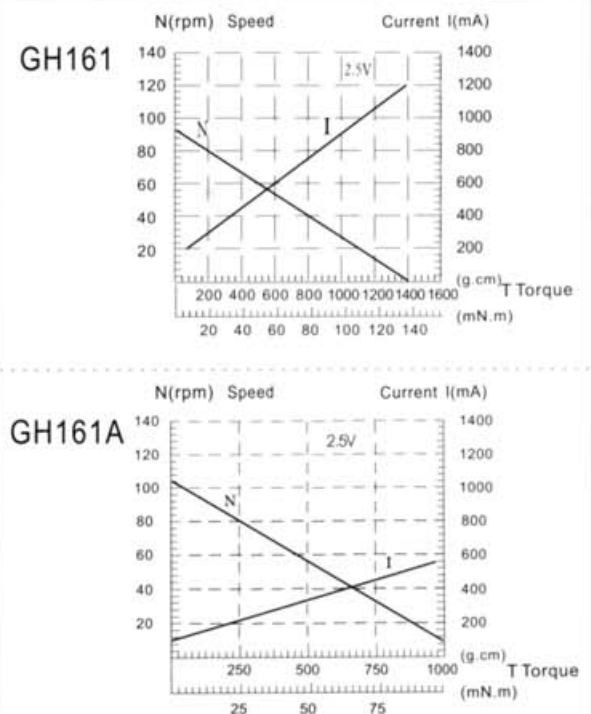

# GH163 Series

Applications: Camare, Vidicon, Household Appliances  
and Toy etc.



Operating environment: -10~+60°C ; 15~90%RH

Characteristics

MODEL	NOMINAL VOLTAGE	RATED LOAD	NO LOAD		RATED LOAD	
			CURRENT	RATED SPEED	CURRENT	RATED SPEED
			V	g.cm	mA	rpm
GH163	2.5	150	≤200	120	≤400	75

Outline Drawing

Characteristics Drawing

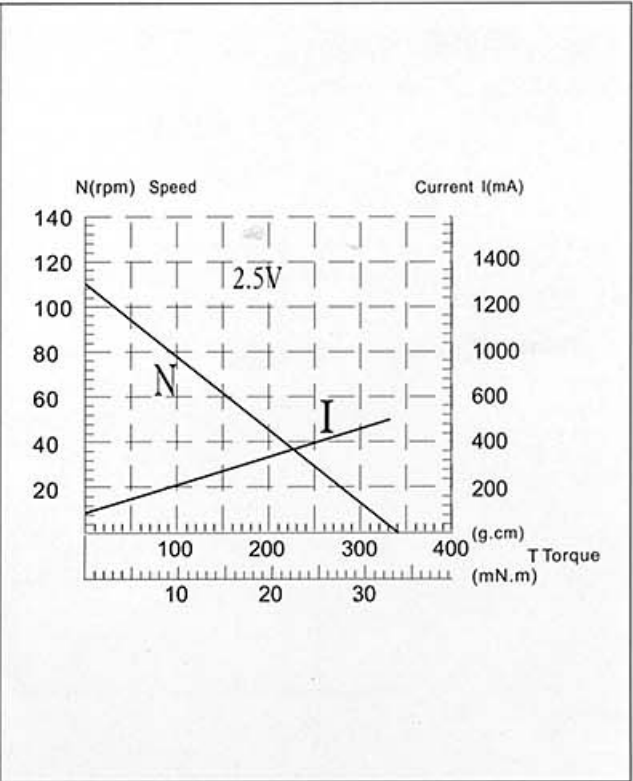
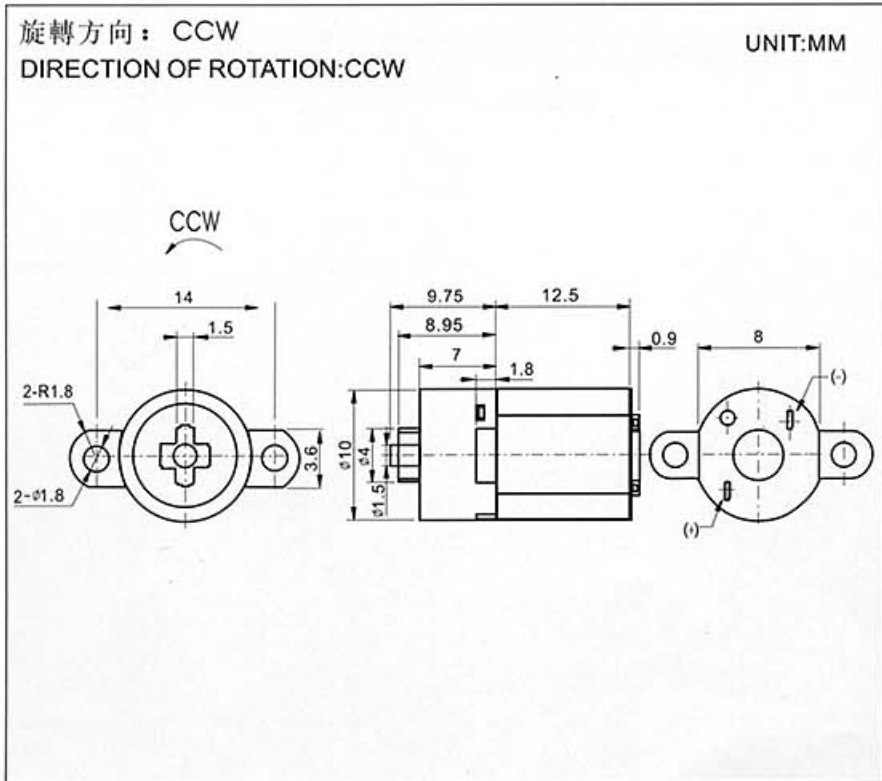

## GH130/132 Series

Applications: Camera, Vidicon, Household

Appliances and Toys etc.

Operating environment:  $-10 \sim +60^{\circ}\text{C}$  ; 15~90%RH



## Characteristics

MODEL	NOMINAL VOLTAGE	RATED LOAD	NO LOAD		RATED LOAD	
			電 流 CURRENT	額定轉數 RATED SPEED	電 流 CURRENT	額定轉數 RATED SPEED
			V	g.cm	mA	rpm
GH130	2.5	300	$\leq 300$	$> 80$	$\leq 600$	$> 55$
GH132	5.0	300	$\leq 120$	80	$\leq 410$	65

## Outline Drawing

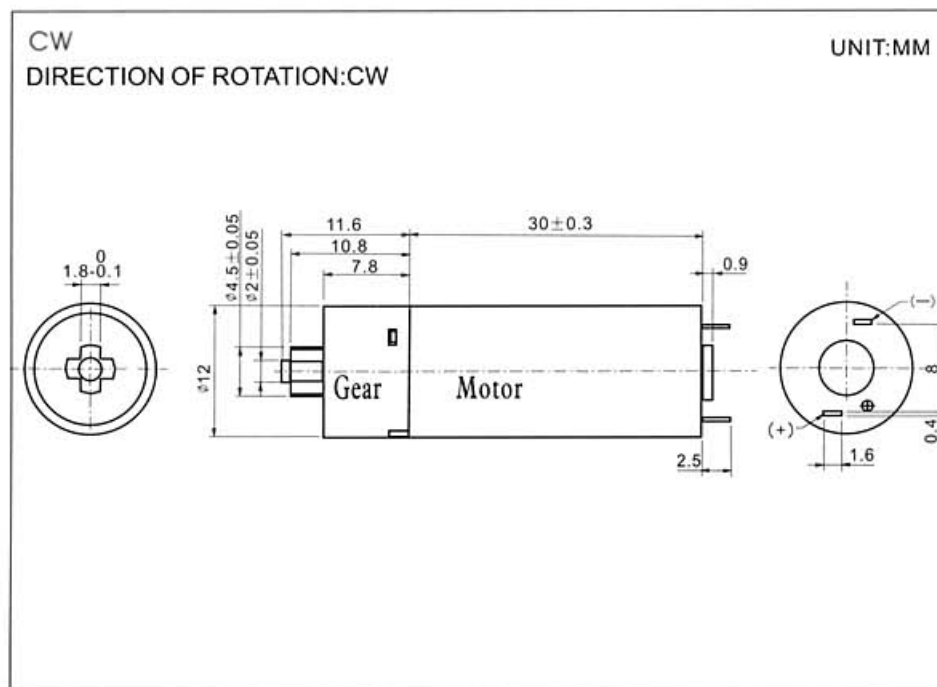

## Characteristics Drawing

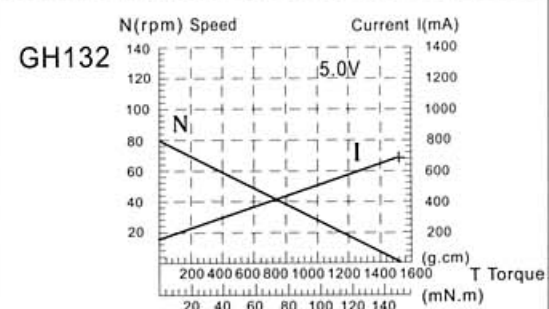
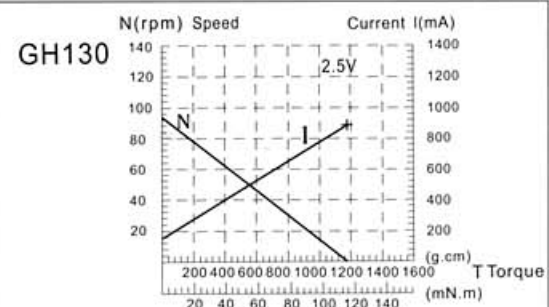

Applications: Camera, Vidicon, Household Appliances  
and Toy etc.

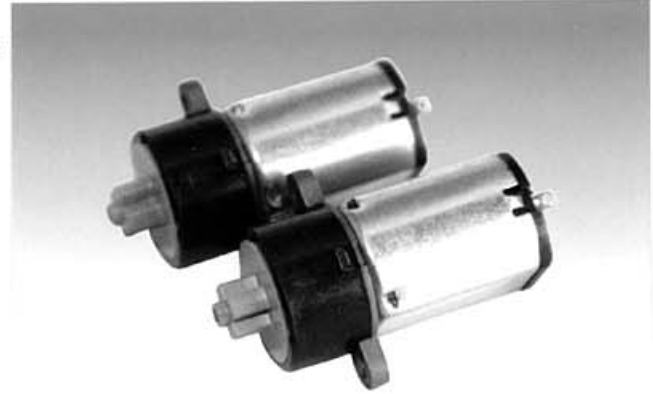

Operating environment:  $-10 \sim +60^{\circ}\text{C}$  ; 15~90%RH

Characteristics

MODEL	NOMINAL VOLTAGE V	RATED LOAD g.cm	NO LOAD		RATED LOAD	
			CURRENT	RATED SPEED	CURRENT	RATED SPEED
			mA	rpm	mA	rpm
GH133	2.5	150	$\leq 200$	$> 70$	$\leq 300$	$> 50$
GH133B	5.0	150	$\leq 100$	$> 70$	$\leq 150$	$> 50$

Outline Drawing

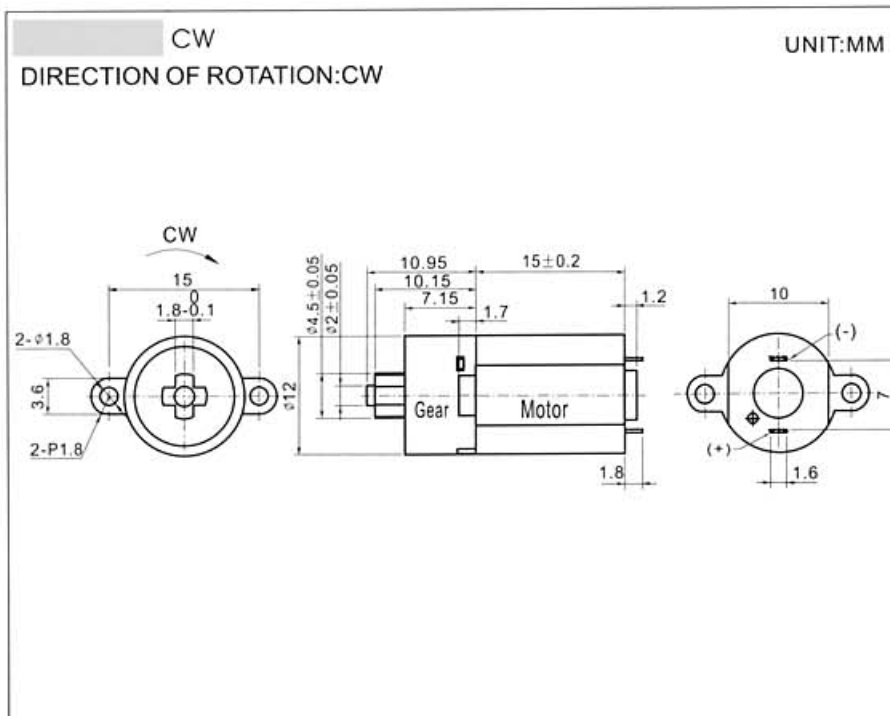

Characteristics Drawing

